

# THE 2

ACTIVE TOURER



# ALL BMW MODELS IN ONE APP.



DOWNLOAD THE **BMW Products** APP NOW  
AND DISCOVER THE PLEASURE OF DRIVING



HIGHLIGHTS

MODELS

EQUIPMENT

TECHNICAL VALUES  
AND SERVICES

## CONTENTS

HIGHLIGHTS	MODELS	EQUIPMENT	BMW SERVICES
EXTERIOR AND INTERIOR DESIGN	BASE	PREMIUM PACKAGE	
COMFORT AND FUNCTIONALITY	LUXURY LINE	INNOVATION PACKAGE	
CONNECTIVITY	M SPORT PACKAGE	EQUIPMENT HIGHLIGHTS	
ASSISTANCE SYSTEMS	PLUG-IN HYBRID	WHEELS AND TYRES	
DRIVING DYNAMICS		EXTERIOR COLOURS	
EQUIPMENT HIGHLIGHTS		INTERIOR COLOUR WORLD	
PLUG-IN HYBRID.		ORIGINAL BMW ACCESSORIES	
CHARGING			

### BMW 2 Series Active Tourer 223i:

Luxury Line, 19" BMW Individual light-alloy wheels Multi-spoke style 839 Bicolor, exterior paintwork in Mineral White, sport seats in Sensatec perforated | Oyster, interior trim finisher in fine-wood trim Eucalyptus open-pored with highlight trim finisher Pearl Chrome, M anthracite headliner.

### BMW 2 Series Active Tourer plugin hybrid 230e xDrive:

M Sport package, 18" M light-alloy wheels Double-spoke style 838 M Bicolor, exterior colour in M Portimao Blue metallic, sport seats in Alcantara/Sensatec combination | Black/contrast stitching in blue, interior trim finishers in Aluminium Hexacube dark with highlight trim finisher Pearl Chrome.

An temperatures below freezing, the electric drive system on this plugin hybrid is only available after a few kilometres of driving, once the battery has heated to operational temperature.

The models illustrated in this medium show the equipment and configuration options (standard and optional) for vehicles produced by BMW AG for the German market. Alterations in standard and optional equipment and the configurations available for the different models may occur after 09/06/2021, the editorial deadline for this medium, or according to the specific requirements of other member states of the European Union. Your local BMW Partner is available to provide further details. Subject to change in design and equipment.



WHETHER A DAY HAS ONLY 24 HOURS  
OR CONSISTS OF COUNTLESS  
UNIQUE MOMENTS DEPENDS  
ENTIRELY ON HOW YOU LIVE IT.

BECAUSE IF THE ROAD IS MORE  
THAN A PATH FROM A TO B, EVEN  
THE SHORTEST ROUTE CAN BECOME  
A JOURNEY OF DISCOVERY.

EXPERIENCE MORE. GET IN. THE NEW  
BMW 2 SERIES ACTIVE TOURER.

EXPERIENCE.  
MORE.  
LIFE.



## STREETLIFE, REINTERPRETED.

Elegance and future orientation, perfectly combined: a unique design language and modern details characterise the unmistakable design of the new BMW 2 Series Active Tourer - dynamic, present and self-confident. For a strong appearance that creates lasting memories. The clear interior design conveys an open and spacious feeling.





## UNMISTAKABLE DYNAMISM.

Clear contours and the wide stance make a confident statement. The contrast between the striking shoulder area and narrow LED rear lights emphasises the sporty dynamics. The exhaust tailpipes remain invisible giving the rear as a whole a superior, unadulterated and authentic look.

## FORWARD MOMENTUM, WRITTEN IN DESIGN.

Reduced, precise lines give the side view of the new BMW 2 Series Active Tourer the appearance of being organically modelled. Its surfaces span the powerfully proportioned flank in a clear and pristine way. The large wheels convey additional presence. Details such as the flush-integrated door handles reinforce this impression: elegance and driving pleasure are clearly paramount here.



## PERSONALITY THROUGH AND THROUGH: THE INTERIOR.

The new BMW 2 Series Active Tourer creates an open and generous feeling of space that impresses with its modern character and maximum suitability for everyday use. Consistently digital, maximally emotional and simply an oasis of well-being on the road – this is an impressive demonstration of how the highest levels of comfort and the most modern technology harmoniously merge to create an experience that triggers fascination anew with every journey.



■ The instrument panel in the new BMW 2 Series Active Tourer is clear, structured and modern. Its centrepiece is the **large, frameless BMW Curved Display**. This elegantly curved display cluster with anti-reflective glass surface consists of a fully digital 10.25" instrument display and a high-resolution 10.70" Control Touch Display. The BMW Curved Display fascinates with its information display perfectly designed for the driver and intuitive operation.

■ In the interior of the new BMW 2 Series Active Tourer, the centre console almost seems to float freely. Ergonomically optimised and tailored to the needs of the driver, it combines all the driving-related functions such as MyModes as a **central control island**. For the first time, the new BMW 2 Series Active Tourer uses modern, multimodal control via voice, touch or steering wheel operation. The result is a clear interior design, characterised by a reduction to the essentials.

■ With a non-slip steering wheel rim and moulded thumb rests, the **Sport leather steering** wheel is exceptionally comfortable to hold. Control functions for the instrument display, audio functions and driver assistance systems, for example, can be selected directly from the steering wheel for maximum convenience and quick access.

■ The elongated interior door mirrors pick up on the horizontal lines of the instrument panel, continuing the clearly structured design of the interior. Side windows and exterior mirrors are arranged in a new, sophisticated layout that provides **optimal all-round visibility**.



■ Standard equipment □ Optional equipment

The availability of some equipment features, functions and digital services depends on engine versions or additional optional equipment. The offer structure as well as market and production availability may vary. For detailed information

about availabilities, duration and costs, contact your local BMW authorised workshop.

## COMFORT FROM START TO FINISH.

Unique comfort and sophisticated functionality on every trip: Every detail of your new BMW 2 Series Active Tourer is designed to make you feel good. It starts with the ample, sporty atmosphere – and continues with intelligent functions and technologies that make each trip even more pleasant. The comfortable optional sport seats for driver and front passenger, which allow a wide range of individual adjustments, offer extra comfort and a dynamic look. In the rear, passengers benefit from adjustable backrests that also increase flexibility: the cargo position and the optional sliding seats expand the luggage compartment capacity and make the BMW 2 Series Active Tourer the ideal partner for all your plans. Simple and intuitively controllable, the innovative automatic air conditioning system ensures the optimum indoor climate at all times. It takes into account a variety of information such as the number and position of passengers. Based on the individual user specifications, the system automatically adjusts the existing additional components, records all adjustments to the climate settings and saves them – feeling good has never been easier.



□ Every seat is a hit: regardless of whether you choose the **standard seats** or the **sport seats**, you will always enjoy the highest level of comfort thanks to an extensive range of adjustments – precisely adaptable to your wishes and preferences and optionally available with the **Active Seats<sup>1</sup> with massage function**.

□ The lighting functions and light sources of the **Light package**, such as front entry and exit lights, footwell and reading lights, make the modern ambience of the new BMW 2 Series Active Tourer as fascinating in the dark as it is during the day. The optional contour and ambient lighting emphasises the clear and avant-garde design and sets targeted highlights in the vehicle cockpit.



■ Standard equipment   □ Optional equipment

The availability of some equipment features, functions and digital services depends on engine versions or additional optional equipment. The offer structure as well as market and production availability may vary. For detailed information

about availabilities, duration and costs, contact your local BMW authorised workshop.

<sup>1</sup> Planned availability: 03/2022.

## DRIVING EXPERIENCE. REDEFINED.

BMW iDrive opens up new horizons in the interaction between vehicle occupants and vehicle – innovative, intelligent and multimodal. The standard operating concept enables intuitive control of various vehicle and infotainment functions. You decide how to operate your BMW 2 Series Active Tourer: by touch or voice. For example, you can set your desired vehicle climate either via the touch function of the BMW Curved Display or simply by voice command – the intelligent interaction of all the components takes care of everything else. In this way, every interaction with the new BMW 2 Series Active Tourer is even more emotional and personal.

□ **BMW Live Cockpit Professional** allows you to have a good view of all the driving-related data at all times. In addition to the functions of BMW Live Cockpit Plus, the integrated Head-up display<sup>1</sup> projects selected information directly into your field of view for even greater comfort and safety. With Augmented View, you also experience a completely new kind of navigation guidance.

□ Navigating is now even more comfortable: **Navigation guidance with Augmented View** superimposes turn-by-turn directions, lane suggestions and other important information in a live video stream on the Control Touch Display of the new BMW 2 Series Active Tourer. This means that you always know where to go almost intuitively – and can enjoy relaxed driving pleasure.

■ Reach your destination quickly and conveniently with **BMW Maps Navigation**. Available as standard in the BMW Live Cockpit Plus, this cloud-based navigation system is intuitive to use and allows destinations to be entered via free text or voice. Your route is calculated dynamically according to real-time data. BMW Maps always shows you the quickest way to your destination and points out interesting places nearby.

■ The **BMW Intelligent Personal Assistant** not only has all the answers to any question about the new BMW 2 Series Active Tourer but, in conjunction with the standard **BMW Curved Display**, it becomes a personal assistant and intelligent front passenger who supports you during the journey and adapts functions to your individual needs and routines - operated intuitively via voice control.

■ Smart, up-to-date, and sophisticated: with its contemporary design and intuitive user prompting, the **My BMW App** accompanies you through a whole new mobility experience. Plan your next trip, check the status of your BMW, book your next service appointment or use one of the numerous remote control functions – all conveniently from your smartphone.



■ Standard equipment □ Optional equipment

The availability of some equipment features, functions and digital services depends on engine versions or additional optional equipment. The offer structure as well as market and production availability may vary. For detailed information

about availabilities, duration and costs, contact your local BMW authorised workshop.

<sup>1</sup> The information in the BMW Head-Up Display is not fully visible when viewed through polarised sunglasses. Content shown will depend on the equipment options chosen. Further optional equipment is required to display specific items.



## SAFELY AT YOUR SIDE.

The new BMW 2 Series Active Tourer is always at your side, providing reliable support even in challenging driving situations. An intelligent combination of sensor system, assistance functions and safety technologies make sure you feel perfectly comfortable during every trip and can master any situation with superiority.



▣ **Driving Assistant Professional<sup>1</sup>** provides more comfort and safety for monotonous or unclear driving situations: apart from the functions of the Driving Assistant, it includes numerous other features. For example, it supports you on long journeys by taking over the Cruise Control and steering function, thus helping you to drive in a relaxed manner.

■ Lane Departure Warning with active lane return, Collision Warning with braking function, Speed Limit Info incl. anticipation and no-overtaking indicator and more – the **Active Guard** equipment ensures that every journey is even more pleasant, safe and comfortable thanks to comprehensive, camera-based driver assistance systems.

■ The camera and ultrasound-based **Parking Assistant<sup>2</sup>** with Active Park Distance Control and Reversing Assist Camera not only indicates collision-critical obstacles in the rear and side areas, but also facilitates parking in parallel, perpendicular and confined parking bays by taking over complete vehicle control with steering, braking and gear selection when parking. Every journey in the new BMW 2 Series Active Tourer ends as pleasantly as it began.

■ Standard equipment    ▣ Optional equipment

The availability of some equipment features, functions and digital services depends on engine versions or additional optional equipment. The offer structure as well as market and production availability may vary. For detailed information

about availabilities, duration and costs, contact your local BMW authorised workshop.

<sup>1</sup> Function may be limited in darkness, fog or bright glare.

<sup>2</sup> The driver is responsible for constantly monitoring the automatic parking manoeuvre in accordance with German road traffic regulations.

# ADRENALINE? EVERY DAY!

Thrills again and again – with every acceleration and in every curve: the new BMW 2 Series Active Tourer impresses with total driving pleasure from the first instant. Accurate self-steering properties, superior power delivery and euphoric dynamics combined with impressive efficiency make every journey in the new BMW 2 Series Active Tourer the ultimate experience - regardless of which route you choose.



■ More dynamics and high efficiency: in the BMW 220i and BMW 223i, **mild hybrid technology** reduces fuel consumption and increases the power of your new BMW 2 Series Active Tourer. The 48V recuperation system includes an electrical machine integrated into the automatic transmission and an additional battery under the luggage compartment floor. So when you take your foot off the accelerator or brake, your BMW automatically converts kinetic energy into electrical energy. When you accelerate, additional electric drive power is available to you ensuring a particularly dynamic power delivery. Adaptive recuperation<sup>1</sup>, which intelligently adjusts the level of deceleration depending on the situation, is available as an option.

■ Traction, directional stability and driving safety with maximum agility and characteristic BMW dynamics at the same time: The intelligent **xDrive<sup>2</sup>** all-wheel drive brings together features that ensure you enjoy your time behind the wheel – no matter what the road surface.

■ Extremely fast gear changes, a high level of shifting comfort and optimised efficiency – the **Steptronic transmission with double clutch** inspires with exceptionally high shifting dynamics for more driving pleasure and, at the same time, offers all the comfort features of an automatic transmission.

□ The **adaptive M suspension<sup>3</sup>**, which has been lowered by 15 mm, automatically adapts to the road conditions and driving style. You benefit from pronounced driving dynamics and excellent roadholding, while enjoying a

high level of driving comfort and improved long-distance capability. The exclusive **M sport steering** gives a more direct steering sensation.

<sup>1</sup> Only available in conjunction with Driving Assistant Plus or Driving Assistant Professional.

<sup>2</sup> BMW xDrive is available for the BMW 223i xDrive and 225e xDrive models as well as the 230e xDrive (expected from 07/2022).

<sup>3</sup> Plug-in hybrid models without lowered suspension.

■ Standard equipment □ Optional equipment

The availability of some equipment features, functions and digital services depends on engine versions or additional optional equipment. The offer structure as well as market and production availability may vary. For detailed information

about availabilities, duration and costs, contact your local BMW authorised workshop.



## SIMPLY MORE FROM THE START.

In the new BMW 2 Series Active Tourer you enjoy the good feeling of no compromise from the very first moment. Already the standard version impresses with equipment that combines the best of comfort, networking, safety and design. With flexible functions and services that you can easily add later, you'll always be up to date – for a driving experience that feels excitingly new every time.

■ Thanks to **extensive standard equipment** such as the BMW Curved Display, an automatic tailgate, Parking Assistant with Reversing Assist Camera, BMW Maps Navigation and more, every journey in the new BMW 2 Series Active Tourer is an extraordinary experience from the very first metre. But even beyond that, you will find exactly the BMW 2 Series Active Tourer that best suits you in a perfectly tailored range structure.

□ With the new BMW 2 Series Active Tourer you always have exactly the functions and services you need. Keep your vehicle up to date with **Remote Software Upgrade** and **Functions on Demand**<sup>1</sup>. The new BMW 2 Series Active Tourer is thus prepared for the activation of Driving Assistant Plus with the corresponding equipment package.

■ Standard equipment   □ Optional equipment

The availability of some equipment features, functions and digital services depends on engine versions or additional optional equipment. The offer structure as well as market and production availability may vary. For detailed information

about availabilities, duration and costs, contact your local BMW authorised workshop.

<sup>1</sup> Functions expected to be available in Q3/2022.



## SUSTAINABLE DRIVING PLEASURE. MAXIMUM FLEXIBILITY.

The BMW 2 Series Active Tourer plugin hybrid combines the electric drive technology BMW eDrive with a powerful BMW combustion engine. Together, they create a driving experience that combines maximum efficiency with outstanding driving pleasure: depending on the driving mode, either with zero local emissions and pleasantly quiet or with a captivatingly high torque and enough reserves even for longer distances. The recuperation feature also makes a valuable contribution to this: if you take your foot off the accelerator or brake lightly, the BMW 2 Series Active Tourer plugin hybrid automatically converts kinetic energy into electrical energy which is fed into the battery. This way, you can enjoy the typical fascinating feeling of sustainable mobility for even longer.



■ Accents in BMW i Blue around the BMW badges and the electrified by i logo identify the BMW 2 Series Active Tourer plugin hybrid as an electric vehicle.

## SUSTAINABLY IMPRESSIVE: PERFORMANCE AND DRIVING DYNAMICS.

The new BMW 2 Series Active Tourer plugin hybrid in the vehicle type BMW 230e xDrive accelerates from zero to one hundred with power up to 240 kW (326 PS)<sup>1</sup> in 5.7 seconds. The BMW 225e xDrive masters the standard sprint with 180 kW (245 PS)<sup>1</sup> in 7 seconds. The intelligent BMW xDrive all-wheel drive system smoothly and variably distributes driving power to the front and rear wheels for added traction, driving dynamics and driving safety in every driving situation. An **electric range** of up to 80 kilometres<sup>1,2</sup> and short **battery charging times** of less than 2.5 hours<sup>1</sup> from zero to 100 percent with a maximum charging power of 7.4 kW (AC)<sup>1</sup> make the innovative hybrid vehicle a reliable companion in everyday life.

<sup>2</sup> Range depends on various factors. In particular: personal driving style, route characteristics, exterior temperature, heating/air conditioning, pre-conditioning and the chosen equipment. The data for the electric range was determined in the WLTP measuring procedure and takes into account optional equipment.

<sup>1</sup> The information represents preliminary data, final data were not available at the time of going to press.

□ Smart, up-to-date, and sophisticated: with its contemporary design and intuitive user prompting, the **My BMW App** accompanies you through a whole new mobility experience. Plan your next trip, check the status of your BMW, book your next service appointment or use one of the numerous remote control functions – all conveniently from your smartphone.

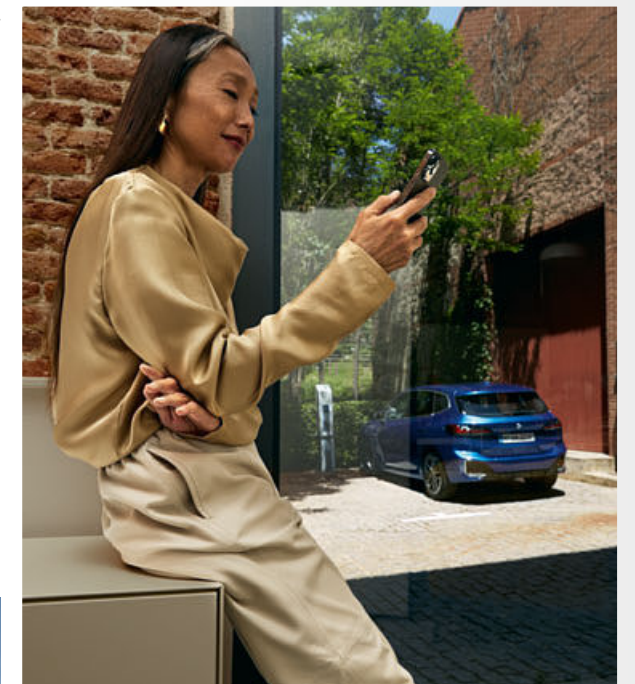

■ Standard equipment □ Optional equipment

The availability of some equipment features, functions and digital services depends on engine versions or additional optional equipment. The offer structure as well as market and production availability may vary. For detailed information

about availabilities, duration and costs, contact your local BMW authorised workshop.



## RAPID CHARGING. DRIVE FURTHER. EXPERIENCE MORE.

BMW Charging is the all-round carefree solution for charging your BMW 2 Series Active Tourer plug-in hybrid. With BMW Charging products and services, you have a wide range of tailor-made offers for charging available at home and on the road. This includes the charging cable for public charging (mode 3), the Flexible Fast Charger and the BMW Charging Card as standard. You have worldwide access to a constantly growing network of charging points in city centres, car parks and along major traffic routes with BMW Charging at particularly good conditions.

## ALL AROUND COMFORT: ADDITIONAL OFFERS OF BMW CHARGING.

□ Enhance your charging equipment with customised BMW Charging solutions. For instance, with a Wallbox to charge your vehicle from home even more conveniently. Choose between the **BMW Wallbox** and **Smart Wallbox** from our partners for comprehensive networking and additional smart services for intelligent charging. Want to conclude a green electricity contract for charging at home, or book our installation service for your Wallbox? Your BMW partner will be happy to help with this and with convenient packages and charging options at work.

## CHARGING MADE EASY.

Want to make best use of your electric drive when you're on the road? No problem. You have everything you need for public charging with you: The fast **charging cable (mode 3)** for public charging is available for straightforward charging on the road. With the **BMW Charging Card**, you can seamlessly access an ample, cross-border charging network. Enjoy especially attractive public charging fees that are optimised in Europe for your specific market, established exclusively for BMW drivers – and with no basic fee to pay in the first year for new vehicle customers. Here, digital **Connected Charging** services guarantee added convenience and transparency when charging by being available at any time directly in the vehicle or using the My BMW App, whether at home or on the road.



■ Standard equipment □ Optional equipment

The availability of some equipment features, functions and digital services depends on engine versions or additional optional equipment. The offer structure as well as market and production availability may vary. For detailed information

about availabilities, duration and costs, contact your local BMW authorised workshop.

## MODEL VARIANTS AT A GLANCE.

### BASE

Experience more life: the new BMW 2 Series Active Tourer.



### LUXURY LINE



The aura of exclusivity: the new BMW 2 Series Active Tourer with Luxury Line.

### M SPORT PACKAGE<sup>1</sup>



More sports car: the new BMW 2 Series Active Tourer with M Sport package.

### BMW PLUG-IN HYBRID<sup>2</sup>



The best of two worlds: The new BMW 2 Series Active Tourer plugin hybrid<sup>1</sup>

## BASE.

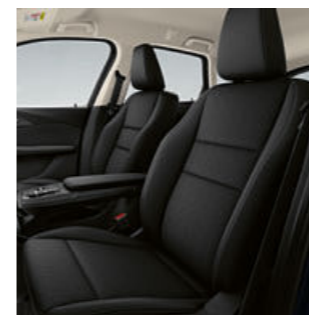

■ The standard seat for the driver and front passenger support a multitude of ergonomic settings. The seat height, seat longitudinal direction, backrest angle and headrest restraint height can be adjusted manually. A map pocket is located on the rear panel. The seat belt buckle pretensioner and belt force limiter increase occupant safety.

■ The black sport leather steering wheel incl. multifunction features moulded thumb rests for a particularly pleasant and high-grip feel. A Pearl Chrome trim element on the steering wheel spokes adds a refined look. You can manually adjust the height and depth of the steering wheel for optimal positioning.



■ 16" light alloy wheels Double-spoke style 186 Silver Grey, wheel size 7J x 16 with 205/65 R16 tyres.

□ 17" light alloy wheels Star-spoke style 875 Light Grey, wheel size 7J x 17 with 205/60 R17 tyres.<sup>1</sup>

#### SELECTED BASE MODEL EXTERIOR EQUIPMENT FEATURES:

- 16" light alloy wheels Double-spoke style 186 silver-grey
- LED headlights & tail lights
- Automatic tailgate operation
- Parking Assistant with Reversing Assist Camera

#### SELECTED BASE MODEL INTERIOR EQUIPMENT FEATURES:

- Cloth 'Arktur' Anthracite
- Interior trim finishers Quartz Silver matt, grained
- Sport leather steering wheel
- Steptronic transmission with double clutch
- BMW Curved Display
- BMW Live Cockpit Plus with BMW Maps Navigation
- BMW Intelligent Personal Assistant
- 2-zone automatic air conditioning
- Lights package

■ Standard equipment □ Optional equipment

<sup>1</sup> Basic wheel for the 223i motorisation.

The availability of some equipment features, functions and digital services depends on engine versions or additional optional equipment. The offer structure as well as

market and production availability may vary. For detailed information about availabilities, duration and costs, contact your local BMW authorised workshop.

<sup>1</sup> The BMW M Sport package models pictured are shown with M high-gloss Shadowline exterior trim with extended features available as an option.

<sup>2</sup> The BMW plugin hybrids pictured are shown with the M Sport package available as an option.

## LUXURY LINE.

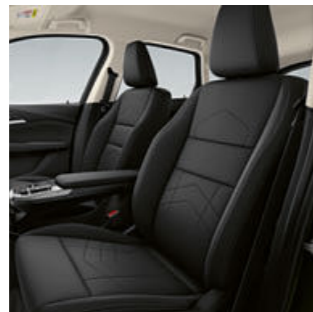

■ Interior trim finishers fine-wood trim eucalyptus open-pored with Pearl Chrome finisher on instrument panel and front doors and additional accent trim strip on centre console

■ The standard seat for the driver and front passenger support a multitude of ergonomic settings. The seat height, seat longitudinal direction, backrest angle and headrest restraint height can be adjusted manually. A map pocket is located on the rear panel. The seat belt buckle pretensioner and belt force limiter increase occupant safety.

■ 17" light alloy wheels V-spoke style 833 Bicolour Dark Grey, gloss-lathed, wheel size 7J x 17 with 205/60 R17 tyres.

□ 18" light alloy wheels Star-spoke style 837 Bicolour Black Grey with performance tyres, gloss-lathed, wheel size 7.5J x 18 with 225/50 R18 tyres.

### LUXURY LINE EXTERIOR EQUIPMENT:

- Front kidney grille with slats in satin aluminium
- Front bumper with specific design elements in satin aluminium
- Centre section air inlet front apron in line-specific design with trim strip in satin aluminium
- Rear bumper panel with trim strip in satin aluminium
- 17" light alloy wheels V-spoke style 833 Bicolour; other wheels available
- BMW Individual Exterior Line Satin Aluminium, alternatively M High-gloss Shadowline exterior trim
- Roof mouldings in body colour

### LUXURY LINE INTERIOR EQUIPMENT:

- Entry sills in aluminium with BMW inscription
- Standard seats for driver and front passenger in Sensatec with perforation, black; other upholstery available
- Open-pored eucalyptus fine-wood interior trim; other strips available

■ Standard equipment □ Optional equipment

The availability of some equipment features, functions and digital services depends on engine versions or additional optional equipment. The offer structure as well as market and production availability may vary. For detailed information

about availabilities, duration and costs, contact your local BMW authorised workshop.

## M SPORT PACKAGE.<sup>1</sup>



■ The M leather steering wheel including multifunction and an integrated driver's airbag is featured in the specific BMW M three-spoke design. With a steering wheel rim in black leather 'Walknappa' with black stitching and contoured thumb rests, it provides a direct, sporty steering sensation – not least thanks to integrated shift paddles.

■ Dynamic and comfortable: The individually adjustable sport seats for driver and front passenger feature numerous adjustment options, including seat depth and tilt. The raised seat and backrest side supports as well as the pronounced shoulder support offer excellent ergonomics and more side support during brisk cornering.

■ 17" M light alloy wheels Double-spoke style 834 M Bicolour Dark Grey, gloss-lathed, wheel size 7J x 17 with 205/60 R17 tyres.

□ 18" M light alloy wheels Double-spoke style 838 M Bicolour Dark Grey with performance tyres, gloss-lathed, wheel size 7.5J x 18 with 225/50 R18 tyres.

### M SPORT PACKAGE EXTERIOR EQUIPMENT:

- Kidney frame in chrome with front sides of the kidney bars in satin aluminium
- Side sill trims with distinctive vehicle-colour design
- Front and rear bumper panels with distinctive vehicle-colour design and Black high-gloss inserts
- 17" M light alloy wheels Double-spoke style 834 M Bicolour; other wheels available
- Adaptive M suspension
- BMW Individual Exterior Line Satin Aluminium, incl. cover trims on front and rear bumper panels in satin aluminium
- Roof mouldings in body colour
- M designation on the sides
- Alpine White solid paint; other paintwork available

■ Standard equipment □ Optional equipment

<sup>1</sup> The BMW M Sport package models pictured are shown with M high-gloss Shadowline exterior trim with extended features available as an option. The availability of some equipment features, functions and digital services

### M SPORT PACKAGE INTERIOR EQUIPMENT:

- M front entry sills, M driver's footrest and M pedals
- Sport seats for driver and front passenger in Alcantara/Sensatec combination, black with blue contrast stitching; other upholstery available
- M leather steering wheel
- Vehicle key with exclusive M logo
- M anthracite headliner
- Interior trim finishers in Aluminium Hexacube; other trims available

depends on engine versions or additional optional equipment. The offer structure as well as market and production availability may vary. For detailed information about availabilities, duration and costs, contact your local BMW authorised



# BMW PLUG-IN HYBRID.<sup>1</sup>

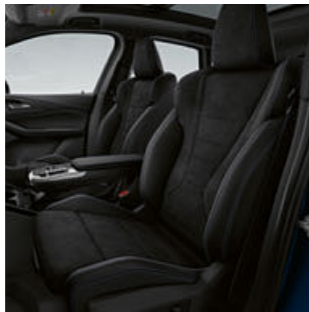

## SELECTED PLUG-IN HYBRID EXTERIOR EQUIPMENT FEATURES:

- 16" light alloy wheels Double-spoke style 186 (applies to 225e)
- 17" light alloy wheels Star-spoke style 875 (applies to 230e)
- Blue accents on the badge and electrified by i inscription
- LED headlights & tail lights
- Automatic tailgate operation
- Maximum charging power 7.4 kW (AC)

## SELECTED PLUG-IN HYBRID INTERIOR EQUIPMENT FEATURES:

- BMW Curved Display
- BMW Live Cockpit Plus
- BMW Intelligent Personal Assistant
- Parking Assistant
- Automatic air conditioning
- Speaker system
- Blue accent on badge
- Pre-temperature setting of the vehicle interior

■ Standard equipment   □ Optional equipment

<sup>1</sup> The BMW plug-in hybrids pictured are shown with the M Sport package available as an option. The availability of some equipment features, functions and digital services

depends on engine versions or additional optional equipment. The offer structure as well as market and production availability may vary. For detailed information about availabilities, duration and costs, contact your local BMW authorised workshop.



## PREMIUM PACKAGE.

Even the basic version of the new BMW 2 Series Active Tourer impresses with its extensive standard equipment. The Premium Package also offers further selected optional equipment for even more driving pleasure. Discover additional information with the **BMW Products App** on your smartphone and tablet.



□ The Luxury instrument panel in black, including the front entry sills, features a finely textured surface and contrast stitching.



□ Interior and exterior mirror package, including automatic dimming interior and driver's side exterior mirrors and electric fold-in function for exterior mirrors.



□ In each case, the preparation for Driving Assistant Plus, seat heating and steering wheel heating is required to retrospectively activate the optional equipment using Functions on Demand. You can find associated information and offers in the My BMW App, online at the BMW ConnectedDrive Store as well as directly in the vehicle.



□ The wireless charging tray allows the inductive charging of mobile devices that support this function.



□ The adaptive LED headlights in an attractive four-eye design feature dynamic lighting functions as well as a Selective Beam.



□ With Comfort Access<sup>1</sup> including BMW Digital Key Plus, you have hands-free access to your BMW both using the vehicle key and using your compatible smartphone. This means you can unlock the vehicle without having to reach for your key or smartphone.

■ Standard equipment □ Optional equipment

<sup>1</sup> To ensure controlled energy management, after a longer stationary period the vehicle only unlocks when the driver moves their hand into the door handle. BMW Digital Key Plus is compatible with selected smartphones only. A list of compatible smartphones is available at [bmw.com/digitalkey](http://bmw.com/digitalkey).

The availability of some equipment features, functions and digital services depends on engine versions or additional optional equipment. The offer structure as well as market and production availability may vary. For detailed information about availabilities, duration and costs, contact your local BMW authorised workshop.

## INNOVATION PACKAGE.

The Innovation package includes all the features of the standard equipment as well as the Premium package and offers additional exclusive optional equipment that makes driving the new BMW 2 Series Active Tourer a special experience. Discover additional information with the **BMW Products App** on your smartphone and tablet.



□ Through the BMW Live Cockpit Professional emerges a frameless BMW Curved Display that combines a 10.25" instrument display and a 10.7" touch display. In addition, relevant information is projected in your visual field via the BMW Head-up Display<sup>1</sup>. An innovative destination guidance experience is presented using Augmented View.



□ The Parking Assistant Plus<sup>2</sup> assistance system has more cameras in addition to the Parking Assistant and also displays the vehicle surroundings in three dimensions. This makes it even easier to monitor the manoeuvre.



□ Augmented View makes navigation easier for you by displaying a live video image from the driver's perspective on the control display. This is supplemented by additional information on route guidance, parking information and places of interest. Symbols in the video image show you where you have to turn or where you are allowed to park, for example.

■ Standard equipment □ Optional equipment

<sup>1</sup> The information in the BMW Head-Up Display is not fully visible when viewed through polarised sunglasses.

<sup>2</sup> The driver is responsible for constantly monitoring the automatic parking manoeuvre in accordance with German road traffic regulations.

The availability of some equipment features, functions and digital services depends on engine versions or additional optional equipment. The offer structure as well as market and production availability may vary. For detailed information about availabilities, duration and costs, contact your local BMW authorised workshop.

# EQUIPMENT HIGHLIGHTS.

Discover the standard equipment highlights of the BMW 2 Series Active Tourer and enhance your comfort with selected optional equipment.



■ The automatic 7-speed Steptronic transmission with double clutch combines high efficiency with particularly smooth gearshifts and outstanding driving comfort, thanks to tightly spaced gear ratios and fast engine speed transitions. You benefit from impressive driving dynamics with low fuel consumption at the same time. A coasting function also increases efficiency.



□ The automatic 7-speed Steptronic transmission with gearshift paddles combines sporty gear change with high efficiency and top driving comfort. Additional shift paddles on the steering wheel allow you to change gears in a particularly direct way without having to take your hands off the steering wheel, ensuring optimal ease of use and high safety.

□ The automatic 7-speed Steptronic sport transmission with double clutch stands for maximum driving dynamics – shift paddles offer a special driving experience and extremely fast gear changes. In SPORT mode, the gear shifts are configured for maximum performance. Launch Control promises the best acceleration from a standing start.

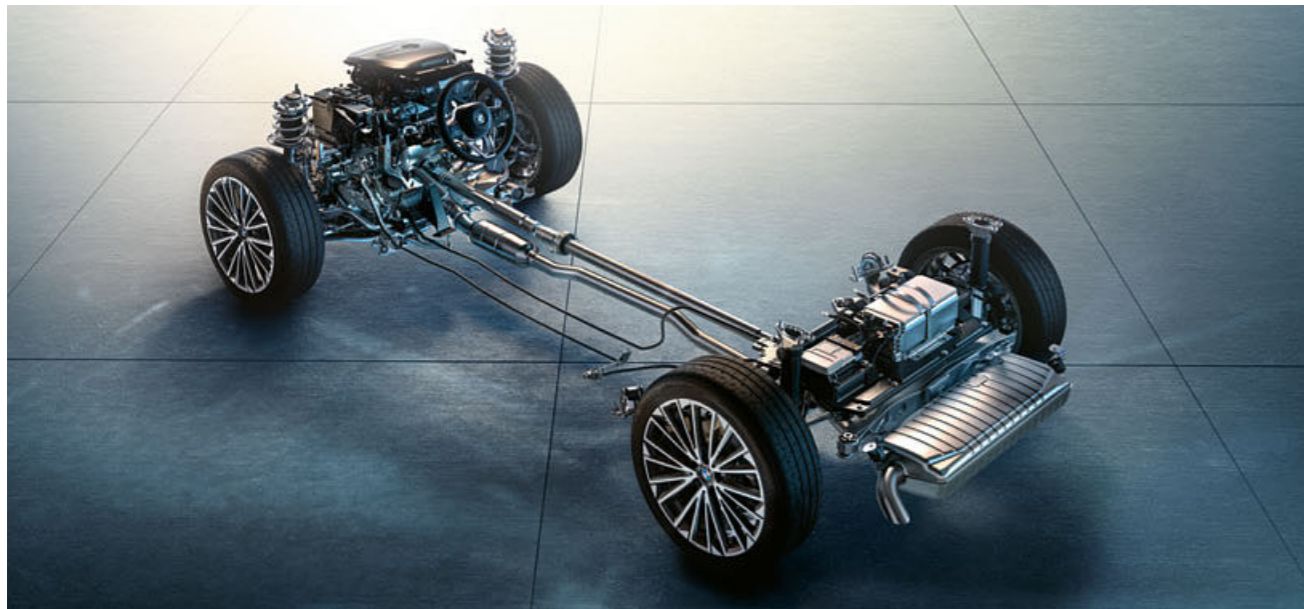

□ The adaptive M suspension<sup>1</sup>, which has been lowered by 15 mm, automatically adapts to the road conditions and driving style. You benefit from pronounced driving dynamics and excellent roadholding, while enjoying a high level of driving comfort and improved long-distance capability. The exclusive M sport steering gives a more direct steering sensation.

■ Standard equipment □ Optional equipment

<sup>1</sup> Plug-in hybrid models without lowered suspension. The availability of some equipment features, functions and digital services depends on engine versions or additional optional equipment. The offer structure

as well as market and production availability may vary. For detailed information about availabilities, duration and costs, contact your local BMW authorised workshop.

# EQUIPMENT HIGHLIGHTS.



□ Keeping an eye on what's important: the BMW Live Cockpit Professional with a large Curved Display, Head-Up Display<sup>1</sup> and the Augmented View destination guidance experience.



■ The BMW Curved Display pairs intuitive operation with a display cluster consisting of a 10.25" instrument display and a 10.7" control display.



■ The BMW Live Cockpit Plus comprises a curved display combination consisting of a 10.25" instrument display and a 10.7" touch control display.

■ The BMW Intelligent Personal Assistant is your personal vehicle expert. It allows you to operate numerous vehicle functions using natural language.

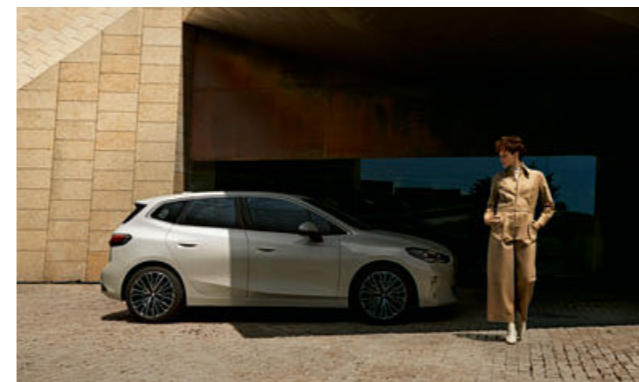

□ Comfort Access<sup>2</sup> including the BMW Digital Key Plus comprises many functions that make it easier for you to access your vehicle.



■ BMW Maps with Connected Navigation and Connected Parking, Connected Music, Remote Services, Smartphone Integration<sup>3</sup> incl. Apple CarPlay and Android Auto, In-Car Experiences and Concierge Service – the Connected Package Professional provides extensive networking capability for your BMW. You benefit from increased comfort and seamless integration of your smartphone apps.

■ Standard equipment □ Optional equipment

<sup>1</sup> The information in the BMW Head-Up Display is not fully visible when viewed through polarised sunglasses.

<sup>2</sup> To ensure controlled energy management, after a longer stationary period the vehicle only unlocks when the driver moves their hand into the door handle. BMW Digital Key Plus is compatible with selected smartphones only. A list of compatible smartphones is available at [bmw.com/digitalkey](http://bmw.com/digitalkey).

<sup>3</sup> Smartphone Integration is permanently available in the vehicle. It includes Apple CarPlay and Android Auto. Due to possible future technical developments (e.g. of

mobile phones), the usability of the Apple CarPlay or Google Android Auto service cannot be guaranteed permanently. CarPlay is a trademark of Apple Inc. Android Auto is a trademark of Google LLC.

The availability of some equipment features, functions and digital services depends on engine versions or additional optional equipment. The offer structure as well as market and production availability may vary. For detailed information about availabilities, duration and costs, contact your local BMW authorised workshop.

# EQUIPMENT HIGHLIGHTS.

□ Driving Assistant Professional<sup>1</sup> offers optimum comfort and safety during critical or monotonous traffic situations. Apart from the contents of the Driving Assistant it also includes Distance Control (ACC with Stop&Go), Steering and Lane Control Assistant with extended functions and Lane Keeping Assistant with active side collision protection.



□ The Driving Assistant Plus<sup>3</sup> feature includes camera and radar-based driver assistance systems such as Distance Control (ACC with Stop&Go) and route control. The package also includes the automatic Speed Limit Assist and the Speed Limit Display with no-overtaking indicator and pre-warning.



□ The Driving Assistant<sup>1</sup> safety package includes Lane Change Warning with active reverse, which helps prevent collisions when changing lanes. The rear crossing traffic warning makes pulling out of parking spaces easier, and brakes in the event of emergency. Rear-end collision and exit warning provide additional safety.

□ The Parking Assistant<sup>2</sup> makes parking the vehicle easier. The Reversing Assist Camera and Reversing Assistant support the driver when reversing. Active Park Distance Control offers increased protection against damage caused by parking. Park Assist automatically parks the vehicle in and out, parallel or perpendicular to the road.



■ The front airbags for the driver and front passenger, the side airbags integrated into the front seat backrests and the head airbags integrated into the roof pillar and A-pillar for all four outer seats are part of the optimally coordinated safety components in your BMW and offer targeted protection in the event of an accident.



□ Every second counts in case of an emergency. The Intelligent Emergency Call reacts automatically if an accident occurs, quickly getting help for you and your passengers.

■ Active Guard<sup>1</sup> includes Lane Departure Warning with lane return, Speed Limit Info incl. pre-warning and no-overtaking indicator as well as the manual Speed Limit Assist. The system warns of vehicles when turning left and brakes in an emergency. The front-collision warning with brake function also helps when turning and at road junctions.

■ Standard equipment □ Optional equipment

<sup>1</sup> Function may be limited in darkness, fog or bright glare.

<sup>2</sup> The driver is responsible for constantly monitoring the automated parking procedure in accordance with local road laws.

<sup>3</sup> Expected in Q2/2022 via Remote Software Upgrade with addition of Steering and Lane Control Assistant.

The availability of some equipment features, functions and digital services depends on engine versions or additional optional equipment. The offer structure as well as market and production availability may vary. For detailed information about availabilities, duration and costs, contact your local BMW authorised workshop.

# EQUIPMENT HIGHLIGHTS.



□ The oscillating seat base<sup>1</sup> function provides optimum seating comfort with an electrically adjustable lumbar support incl. massage function.

□ The Seat heating for driver and front passenger allows for heating of the entire seat base and backrest.

□ The steering wheel heating very quickly warms up the steering wheel rim at the push of a button – a feature that's particularly useful in winter.



□ The electric seat adjustment for driver and front passenger seat with memory function for driver's seat and exterior mirrors increases comfort.



■ Automatic tailgate operation allows the electrical opening and closing of the tailgate by simply pressing the relevant button.

□ Thanks to the seat adjustment for the rear seats, the rear and luggage compartment can be used even more flexibly. The seat cushion surfaces can be shifted separately in length by 130 millimetres in a ratio of 60:40.



□ The trailer tow hitch with electrically adjustable ball head has Trailer Stability Control and an anti-theft mounting.



□ The luggage compartment partition net behind the rear or front seats prevents objects from falling forward into the passenger area.

■ Standard equipment □ Optional equipment

<sup>1</sup> Planned availability: 03/2022.

The availability of some equipment features, functions and digital services depends on engine versions or additional optional equipment. The offer structure

as well as market and production availability may vary. For detailed information about availabilities, duration and costs, contact your local BMW authorised workshop.

## EQUIPMENT HIGHLIGHTS.



□ Panoramic glass sunroof, electric, with slide and tilting functions (front), roller sunblind, a wind deflector and a comfort opening and closing function via the vehicle key.

□ The sun protection glazing prevents the interior from heating up when exposed to direct sunlight.



□ M anthracite headliner: The headliner and upper A-pillar trim panels are finished in Anthracite cloth, complemented by Black details.



□ With its twelve loudspeakers, the loudspeaker system - harman/kardon provides an even distribution of sound in your BMW – including a classy look.



□ The adaptive LED headlights in an attractive four-eye design feature dynamic lighting functions as well as a Selective Beam.



■ The LED headlights emit an exceptionally bright light yet use comparatively little energy.

■ Standard equipment □ Optional equipment

The availability of some equipment features, functions and digital services depends on engine versions or additional optional equipment. The offer structure as well as market and production availability may vary. For detailed information

about availabilities, duration and costs, contact your local BMW authorised workshop.

## EQUIPMENT HIGHLIGHTS.

□ With BMW Individual Exterior Line, selected equipment and design features come in satin aluminium and in Black high-gloss.



□ With the M High-gloss Shadowline, a whole range of exterior features come in Black high-gloss, radiating an athletically exclusive sense of style.



□ The flat roof rails in matt aluminium match perfectly with the vehicle's design, accentuate the roof line and are the key to a multifunctional BMW roof rack unit to which roof boxes, bikes, surfboards etc. can be secured.



□ The flat M roof rails high-gloss Shadowline accentuate the roof line and are the key to a multifunctional BMW roof rack unit.



□ The M high-gloss Shadowline exterior trim with extended features<sup>1</sup> complements the features of the M high-gloss Shadowline with a kidney frame and bars in Black high-gloss.

■ Standard equipment □ Optional equipment

<sup>1</sup> Only available in conjunction with M Sport package. The availability of some equipment features, functions and digital services depends on engine versions or additional optional equipment. The offer structure

as well as market and production availability may vary. For detailed information about availabilities, duration and costs, contact your local BMW authorised workshop.

## WHEELS AND TYRES.

■ 16" light alloy wheels Double-spoke style 186 Silver Grey, wheel size 7J x 16 with 205/65 R16 tyres.



■ 17" light alloy wheels Star-spoke style 832 Silver Grey, wheel size 7J x 17 with 205/60 R17 tyres.<sup>1</sup>



■ 17" light alloy wheels V-spoke style 833 Bicolour Dark Grey, gloss-lathed, wheel size 7J x 17 with 205/60 R17 tyres.<sup>3</sup>



■ 17" M light alloy wheels Double-spoke style 834 M Bicolour Dark Grey, gloss-lathed, wheel size 7J x 17 with 205/60 R17 tyres.<sup>2</sup>

□ 18" M light alloy wheels Double-spoke style 838 M Bicolour Dark Grey, gloss-lathed, wheel size 7.5J x 18 with 225/50 R18 tyres.<sup>2</sup>



□ 17" light alloy wheels Star-spoke style 875 Light Grey, wheel size 7J x 17 with 205/60 R17 tyres.<sup>4</sup>



□ 18" light alloy wheels Star-spoke style 837 Bicolour Black Grey with performance tyres, gloss-lathed, wheel size 7.5J x 18 with 225/50 R18 tyres.



□ 19" BMW light alloy wheels Multi-spoke style 839 I Bicolour Black, gloss-lathed, wheel size 8J x 19 with 225/45 R19 tyres.

■ Standard equipment □ Optional equipment

<sup>1</sup> Available as standard for the 223i and 223i xDrive.  
<sup>2</sup> Only available in conjunction with M Sport package.

<sup>3</sup> Only available in conjunction with Luxury Line.  
<sup>4</sup> Planned availability: 07/2022.

## EXTERIOR COLOUR WORLD.



□ Non-metallic 300 Alpine White<sup>1</sup>



□ Metallic A96 Mineral White<sup>2</sup>

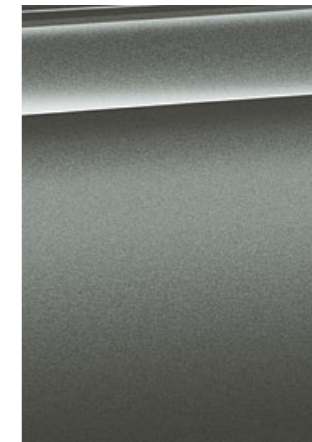

□ Metallic C4W Skyscraper Grey

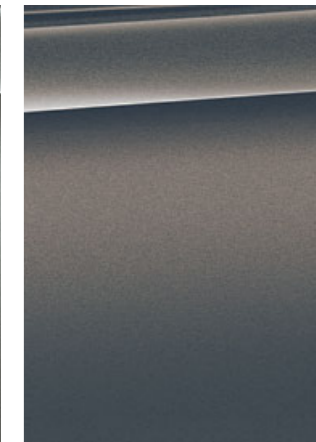

□ Metallic C55 Sparkling Copper Brown

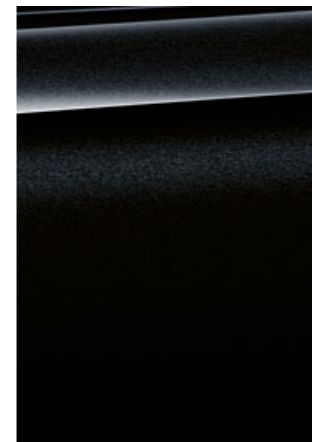

□ Metallic 475 Black Sapphire



■ Non-metallic 668 Black<sup>2</sup>

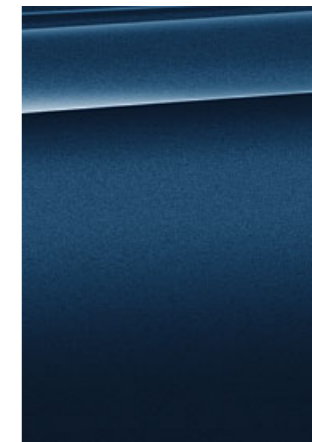

□ Metallic C1M Phytonic Blue<sup>2</sup>



□ Metallic C31 M Portimao Blue<sup>3</sup>

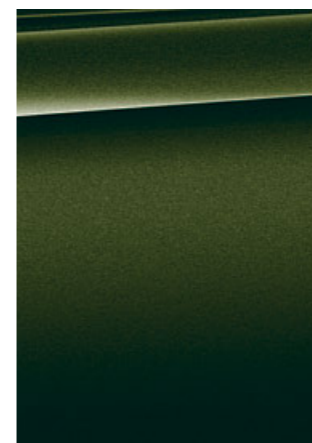

□ Metallic C4E Sanremo Green

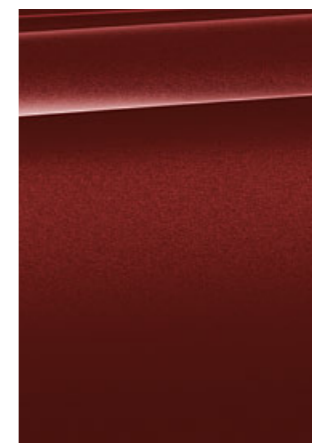

□ Metallic C3C Piemont Red<sup>2,4</sup>



□ BMW Individual C3N Storm Bay metallic

BMW INDIVIDUAL

■ Standard equipment □ Optional equipment –.– Optional equipment without increased/reduced price

**[Colour samples]** These colour samples are intended as an initial guide to the colours and materials available for your BMW. However, experience has shown that printed versions of paint, upholstery and interior trim colours cannot in all cases faithfully reproduce the appearance of the original colour. Please discuss your preferred colour choices with your BMW partner or in your dealership. There you can also see original samples and be assisted with special requests.

<sup>1</sup> Available as standard for the M Sport package.  
<sup>2</sup> Not available in conjunction with M Sport package.

<sup>3</sup> Exclusively available in conjunction with M Sport package.  
<sup>4</sup> Expected to be available from 03/22.

The availability of some equipment features, functions and digital services depends on engine versions or additional optional equipment. The offer structure as well as market and production availability may vary. For detailed information about availabilities, duration and costs, contact your local BMW authorised workshop.

# INTERIOR COLOURS.

## UPHOLSTERY COLOURS



■ Cloth 'Arktur' BLAT Anthracite



■ Alcantara/Sensatec combination KGNL Black, accent Blue<sup>1</sup>



□ Sensatec KHCX perforated Oyster<sup>2</sup>



□ Sensatec KHYM perforated Mocha<sup>2</sup>



□ Sensatec KHSW perforated Black



□ Leather 'Vernasca' MASW Black



□ Leather 'Vernasca' Oyster | Black<sup>2</sup>



□ Leather 'Vernasca' MAMY Mocha<sup>2</sup>



□ Leather 'Vernasca' MASW Black<sup>2</sup>

## INTERIOR TRIM FINISHERS

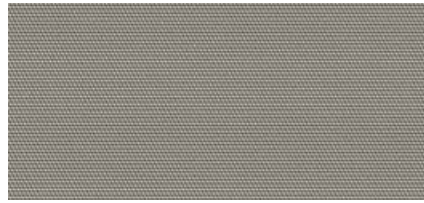

■ Interior trim finishers Quartz Silver matt, grained, on instrument panel

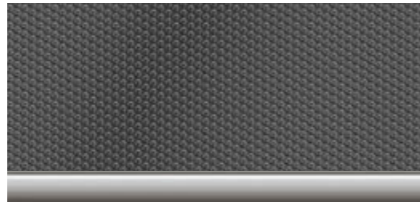

■ Aluminium Hexacube dark interior trim finishers with Pearl Chrome finisher<sup>1</sup>



□ Interior trim finishers fine-wood trim eucalyptus open-pored with Pearl Chrome finisher

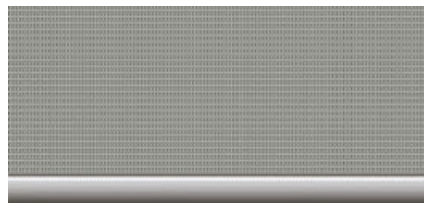

□ Interior trim finishers Aluminium 'Mesheffect' with highlight trim finisher in Pearl Chrome



□ Interior trim finishers Black high-gloss with highlight trim finisher in Pearl Chrome

■ Standard equipment □ Optional equipment –.– Optional equipment without increased/reduced price

<sup>1</sup> Exclusively available in conjunction with M Sport package.  
<sup>2</sup> Only available for sport seats.

Please note that even normal long- or short-term use can lead to unrecoverable upholstery damage. This can be caused in particular by non-colourfast clothing. Please note that the interior colour depends on the selected upholstery colour.

The availability of some equipment features, functions and digital services depends on engine versions or additional optional equipment. The offer structure as well as market and production availability may vary. For detailed information about availabilities, duration and costs, contact your local BMW authorised workshop.



# ORIGINAL BMW ACCESSORIES.

Intensive driving experiences, even further enhanced: Original BMW accessories are the best match for an original BMW. Whether you're looking for wheels and tyres, transport and luggage compartment solutions, interior equipment, communication, information and technology, charging accessories or M performance parts, with genuine BMW accessories you'll find exactly the individual solution that will allow you to discover driving pleasure as if for the first time.



## WHEELS AND TYRES.

With original BMW complete wheels, you'll reach your destination safely, and emphasise the sporty appearance of your BMW from the very first glance. But what you don't immediately realise is that they are precisely tailored to your BMW, are subject to very stringent tests with intensive material and function checks, and have been developed in close collaboration with leading tyre manufacturers – individually tuned to the driving dynamics and design language of each individual BMW model.

## TRANSPORT AND LUGGAGE COMPARTMENT SOLUTIONS.

Original BMW Accessories offer you a wide range of transport and luggage compartment solutions. In line with your personal preferences and interests, you can use them to create additional space whenever and wherever you need it. Whether carrier systems or accessories for the luggage compartment, you can always rely on original BMW accessories to be precisely tailored to your BMW, and easy to use.



## INTERIOR ACCESSORIES.

A perfect fit: all original BMW accessory products for the interior help to design the interior of your BMW to fully meet your personal preferences. In addition to the excellent functionality of original BMW accessories, you are also always choosing attractive BMW design alongside extraordinary craftsmanship and material quality – combined with an ambience that will excite you every time you drive.



## COMMUNICATION, INFORMATION AND TECHNOLOGY.

Cutting-edge functions and features for maximum freedom and flexibility: Original BMW accessories for communication, information and technology are always at your side. Whether you value optimum availability by phone or the best sound, the innovative original BMW accessories will have the right solution for you. You'll always enjoy a good connection and custom entertainment, wherever your journey takes you.

## CHARGING ACCESSORIES.

Regardless of where and how you want to charge your new BMW, original BMW charging accessories offer you tailor-made products and services. You can charge your BMW at any domestic socket using the BMW Flexible Fast Charger or, for even more convenience, at a BMW Wallbox from original BMW accessories; what's more, there's also a widespread network of public charging points available for when you're on the road. Innovative Connected Charging services show charging stations in your BMW's information display, for example, or enable you to easily start pre-conditioning your vehicle just using your smartphone.



## M PERFORMANCE PARTS.

With M performance parts, you can experience BMW's motorsport DNA with fascinating intensity, even off the racetrack. A wide range of technical and visual components makes outstanding technology a visible and tangible experience. Exclusive materials and first-rate quality guarantee flawless dynamism. Experience inspiring maximum product performance: individual, expressive and uncompromising.



## ORIGINAL BMW ACCESSORIES.

BMW offers you a wide range of accessories to maximise your driving pleasure. Design your BMW 2 Series Active Tourer entirely according to your personal wishes and needs. A wide range of other practical and aesthetic genuine BMW accessories is available in addition to the selection shown here. An overview can be found at [shop.bmw.com](https://shop.bmw.com)



o Exclusive 18" BMW light alloy wheel Double-spoke style 838 M in Bicolour Midnight Grey, gloss-lathed. Winter complete wheel with tyre pressure monitor.



16" BMW light alloy wheel Double-spoke style 840 in Jet Black. Winter complete wheel with tyre pressure monitor, compatible with snow chains.

o Light, stable BMW rear bike rack Pro 2.0 for two bikes/e-bikes. Maximum load of 60 kg, can be compactly folded together.



o The modern BMW roof box in black with titanium silver side panels has a storage capacity of 420 litres and is compatible with all BMW roof rack systems. Due to the fact that it can be opened from both sides and has triple central locking on each side it is convenient to load and lock for theft protection.



o The perfectly fitted BMW all-weather floor mats protect the front footwell against moisture and dirt. In Black with BMW lettering.

o Black, fitted, anti-slip and durable BMW luggage compartment mat to protect against dirt and moisture.

o Firm hold for tablets with BMW safety case. The adjustable holder is attached to the basic carrier or to the optional equipment "Travel & Comfort".

o The QHD and full HD cameras of the BMW Advanced Car Eye 3.0 Pro automatically record what is happening in front of and behind the vehicle when an incident takes place.

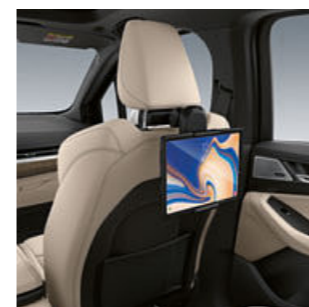

## o Accessories

The time and technical availability of the accessories shown and described may vary depending on the equipment, motorisation and market. Your local BMW partner will be happy to advise you on the full range of original BMW accessories.

The availability of the equipment shown and described may vary on a market-specific basis. Your local BMW partner will be happy to advise you on the full range of original BMW accessories.

Discover the whole range of original BMW accessories and the BMW M performance parts product portfolio.







# TECHNICAL VALUES AND SERVICES

## TECHNICAL VALUES.

BMW 2 Series Active Tourer		218i	220i <sup>6</sup>	223i <sup>6</sup>	223i xDrive <sup>6,7,9</sup>	218d	225e xDrive <sup>5,7,8</sup>	230e xDrive <sup>5,7,8</sup>
<b>Weight and volume</b>								
Unladen weight EC <sup>1</sup>	kg	1545	1595	1620	1690	1620	1920	1935
Maximum permissible weight	kg	2015	2075	2105	2170	2085	2415	2430
Luggage capacity	l	470-1455	415-1405	415-1405	415-1405	470-1455	406-1370	406-1370
Luggage compartment capacity, cargo position	l	565	500	500	500	565	500	500
Tank capacity, approx.	l	45	45	45	45	45	47	47
<b>Complete vehicle drive system<sup>2</sup></b>								
Drive system type	-	Petrol	Petrol – 48 V mild hybrid	Petrol – 48 V mild hybrid	Petrol – 48 V mild hybrid	Diesel	Petrol – plugin hybrid	Petrol – plugin hybrid
Output	kW (hp)	100 (136)	125 (170)	160 (218)	160 (218)	110 (150)	180 (245)	240 (326)
max. torque	Nm	230	280	360	360	360	477	477
Transmission	-	7-speed Steptronic with double clutch	7-speed Steptronic with double clutch	7-speed Steptronic with double clutch	7-speed Steptronic with double clutch	7-speed Steptronic with double clutch	7-speed Steptronic with double clutch	7-speed Steptronic with double clutch
Type of drive	-	Front-wheel drive	Front-wheel drive	Front-wheel drive	All-wheel drive	Front-wheel drive	All-wheel drive	All-wheel drive
<b>BMW TwinPower Turbo engine<sup>2</sup></b>								
Cylinders/valves per cylinder	- / -	3 / 4	3 / 4	4 / 4	4 / 4	4 / 4	3 / 4	3 / 4
Capacity	cm <sup>3</sup>	1499	1499	1998	1998	1995	1499	1499
Nominal power/nominal speed	kW (hp)/rpm	100 (136)/4400-6500	115 (156)/4700-6500	150 (204)/5000-6500	150 (204)/5000-6500	110 (150)/3750-4000	100 (136)/4400	110 (150)/5000
max. torque/rotational speed	Nm/rpm	230/1500-4000	240/1500-4400	320/1500-4000	320/1500-4000	360/1500-2500	230/1500-4000	230/1500-4400
<b>Electric motor (drive system front axle)</b>								
Electric motor type	-	-	synchronous, permanently excited	synchronous, permanently excited	synchronous, permanently excited	-	-	-
Position	-	-	Integrated into automatic transmission	Integrated into automatic transmission	Integrated into automatic transmission	-	-	-
Rated output	kW (hp)	-	14 (19)	14 (19)	14 (19)	-	-	-
max. torque	Nm	-	55	55	55	-	-	-
<b>Electric motor (drive system rear axle)</b>								
Electric motor type	-	-	-	-	-	-	synchronous, current excited	synchronous, current excited
Position	-	-	-	-	-	-	Rear axle	Rear axle
Rated output	kW (hp)	-	-	-	-	-	80 (109)	130 (177)
max. torque	Nm	-	-	-	-	-	247	247
<b>Driving performance</b>								
Top speed	km/h	214	221	241	238	220	195	205
Top electric speed	km/h	-	-	-	-	-	140	140
Acceleration 0-100 km/h	s	9.0	8.1	7.0	6.9	8.8	7.0	5.7
<b>Consumption and CO<sub>2</sub> emissions (WLTP)<sup>2,3</sup></b>								
Exhaust emissions standard (type-certified)	-	EU6d	EU6d	EU6d	EU6d	EU6d	EU6d	EU6d
Combined fuel consumption, PHEV weighted <sup>7</sup>	l/100 km	6.8-6.2	6.5-5.9	6.6-6.0	7.3-6.6	5.3-4.8	1.4-1.1	1.4-1.1
Combined CO <sub>2</sub> emissions, PHEV weighted <sup>7</sup>	g/km	154-140	148-133	149-137	165-150	138-125	30-22	30-22
Combined power consumption, PHEV weighted <sup>7</sup>	kWh/100 km	-	-	-	-	-	20.0-17.9	20.0-17.9
<b>Range (WLTP)<sup>3</sup></b>								
Electric range, EAER combined <sup>4</sup>	km	-	-	-	-	-	69-80	69-80
<b>Electric charging</b>								
AC charging: Charging time 0-100 %/ max. vehicle charging power	h:min/kW	-	-	-	-	-	< 02:30/7.4	< 02:30/7.4
<b>Battery</b>								
Battery type/energy content	-/kWh	-	Li-ion/0.9	Li-ion/0.9	Li-ion/0.9	-	Li-ion/14.9	Li-ion/14.9
<b>Wheels/tyres</b>								
Standard wheels	-	205/65 R16 95 W	205/65 R16 95 W	205/60 R17 97 W XL	205/60 R17 97 W XL	205/65 R16 95 W	205/65 R16 95 W	205/60 R17 97 W XL

The figures for performance, fuel consumption and CO<sub>2</sub> emissions refer to vehicles with standard transmission.

<sup>1</sup> The EC unladen weight refers to a vehicle with standard equipment and does not include any optional equipment. The unladen weight includes a 90% full tank and a driver weight of 75 kg. Optional equipment may affect the weight of the vehicle, the payload and the top speed if the selected equipment has an impact on the vehicle's aerodynamics.

<sup>2</sup> Performance data of petrol engines apply to vehicles using RON 98 fuel. Fuel consumption data apply to vehicles using reference fuels in accordance with EU Regulation 715/2007. Unleaded RON 91 and higher with a maximum ethanol content of 10% (E10) may also be used. BMW recommends RON 95 unleaded premium grade fuel.

<sup>3</sup> Official data for fuel consumption, CO<sub>2</sub> emissions, power consumption and electric range was determined in accordance with the prescribed measuring procedure and corresponds to European Regulation (EC) 715/2007 in the applicable version. For ranges, data determined as per WLTP takes into account any optional equipment (available on the German market in this case). For vehicles that have been newly type approved since 1 January 2021, only the official data according to WLTP exists. For more information about NEDC and WLTP measuring procedures visit [www.bmw.com/wltp](http://www.bmw.com/wltp)

<sup>4</sup> Range depends on various factors, in particular: individual driving style, route characteristics, outside temperature, heating/air conditioning, pre-conditioning.

<sup>5</sup> At temperatures below freezing, the electric drive system on this plugin hybrid is only available after a few kilometres of driving, once the battery has heated to operational temperature.

<sup>6</sup> This engine version is not available in all countries. For further information, please contact your local BMW authorised workshop.

<sup>7</sup> Provisional figures; any missing figures were unavailable at the time of publication.

<sup>8</sup> Expected to be available from 07/22.

<sup>9</sup> Expected to be available from 03/22.

## TECHNICAL VALUES.

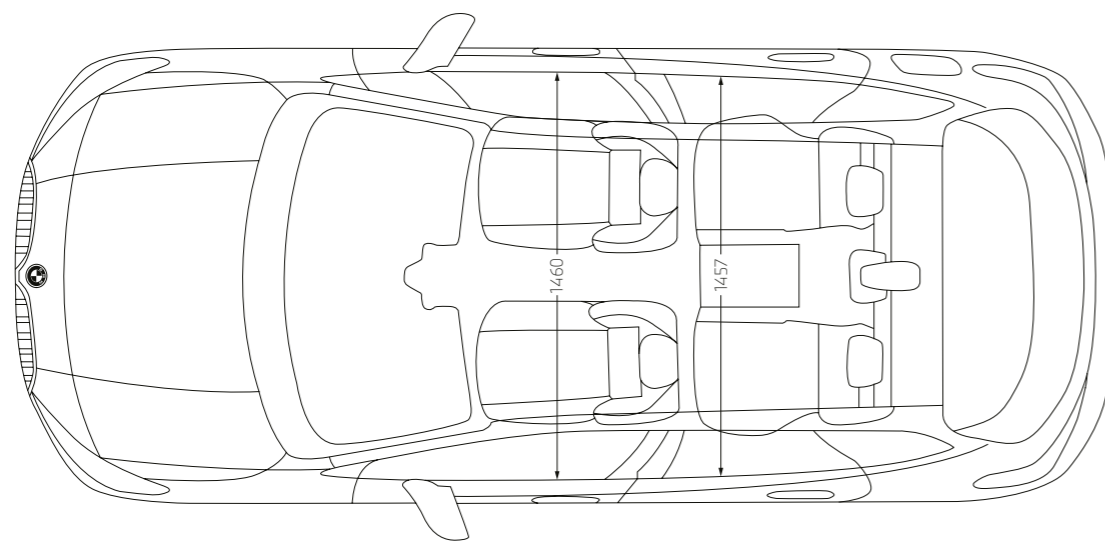
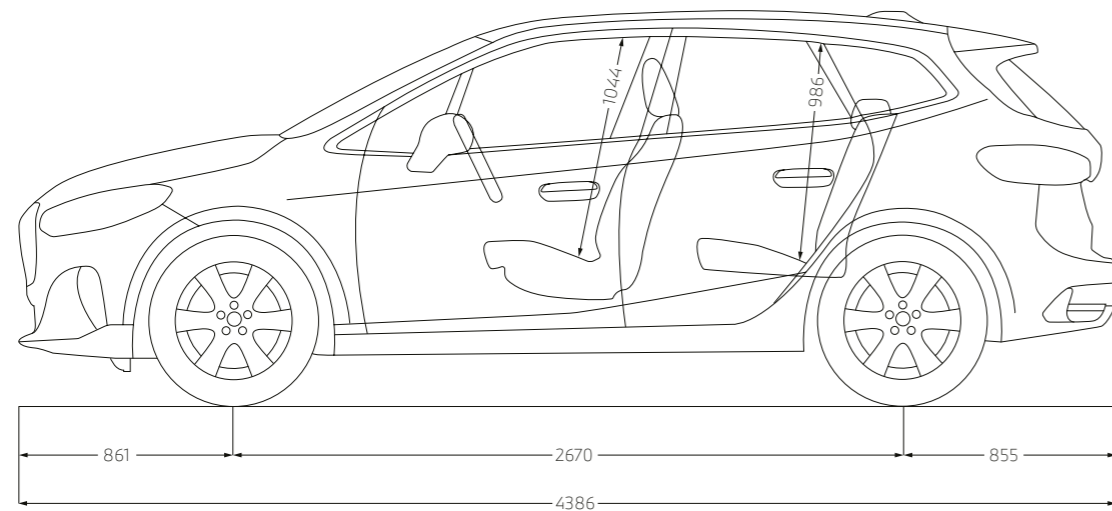
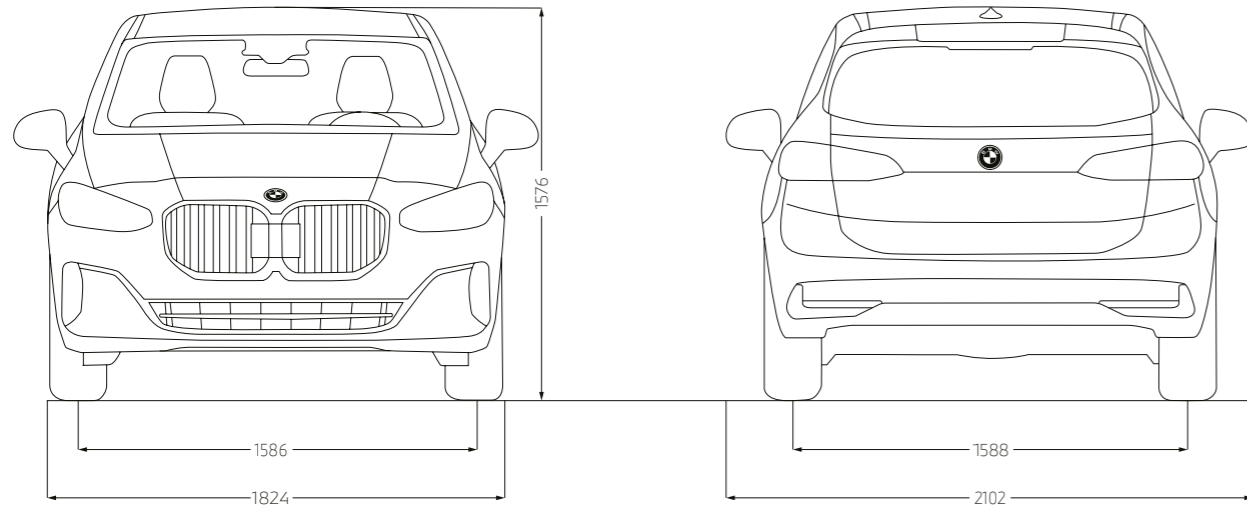

The dimensions in the technical drawing are in millimetres and may vary depending on the model and optional equipment.



## BMW SERVICES.



Always there for you: Your BMW Service Partner is there for helpful, expert support for everything to do with your BMW. Our aim is to make every journey in your BMW as pleasant as possible. A major worldwide network of workshops offers premium service from BMW specialists, innovative diagnostic technologies, and rapid availability of precisely fitting original BMW parts as well as original BMW engine oil. There are many great reasons to choose services from BMW, but there's one that really stands out: that driving pleasure that sets your BMW apart from the crowd will be yours to enjoy for many years to come with BMW Service.

## WHEREVER, WHENEVER: OUR COMPREHENSIVE SERVICE.

Many BMW services can be easily booked and tracked online – so you can use your time for the really important things in life. Stay independent and flexible with online appointments and remote services. Take advantage of our innovative digital products and services such as online video advice, and get all the relevant information on your smartphone. And if you don't want to stop but have no choice, our BMW Breakdown and Accident Assistance service will help.



Of course, each vehicle is designed for economical recycling after its long-running life.  
You can find more information regarding your end-of-life vehicle on our website  
**[www.bmw.de/recycling](http://www.bmw.de/recycling)**

© BMW AG, Munich, Germany. Not to be reproduced wholly or in part without prior written permission of BMW AG, Munich.

411 002 449 20 2 2021 CB. Printed in Germany 2021.